

# SHOOTING ACADEMY OPEN 2022 (Rifle)

## STAGE 1

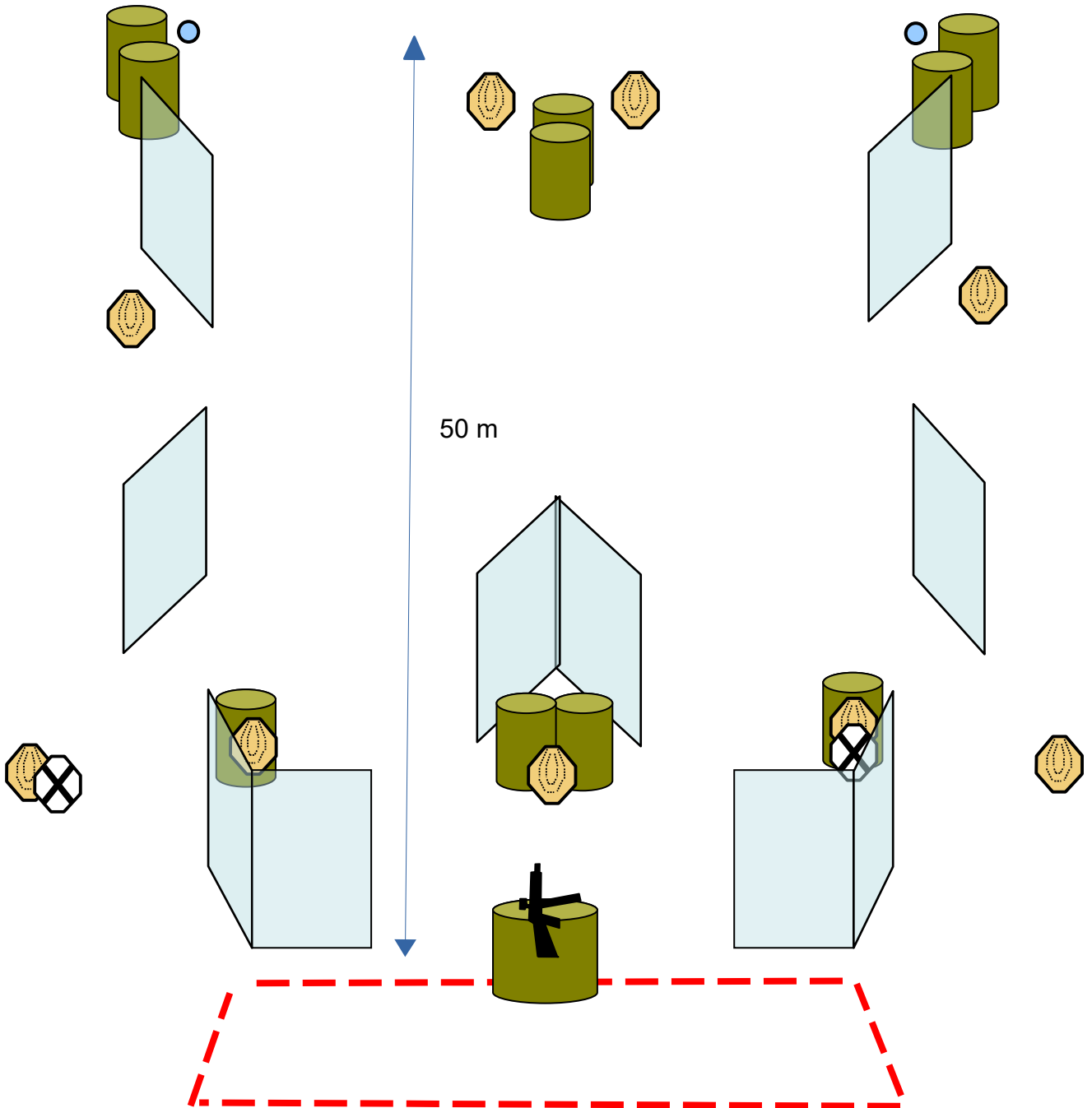

**STAGE: 1** (Medium Course).

**TARGETS:** IPSC MINI Targets 9, IPSC Plates 2, No-Shoots 2.

**MINIMUM NUMBER OF ROUNDS:** 20.

**(Maximum points: 100)**

**START POSITION:** Standing anywhere in the designated area, facing downrange.

**THE RIFLE READY CONDITION:** Loaded (Option 2), magazine filled and fitted, chamber empty, action closed, placed on the table, muzzle pointed downrange.

**TIME START:** Audible signal.

**PROCEDURE:** After start signal engage all targets.

# SHOOTING ACADEMY OPEN 2022 (Rifle)

## STAGE 2

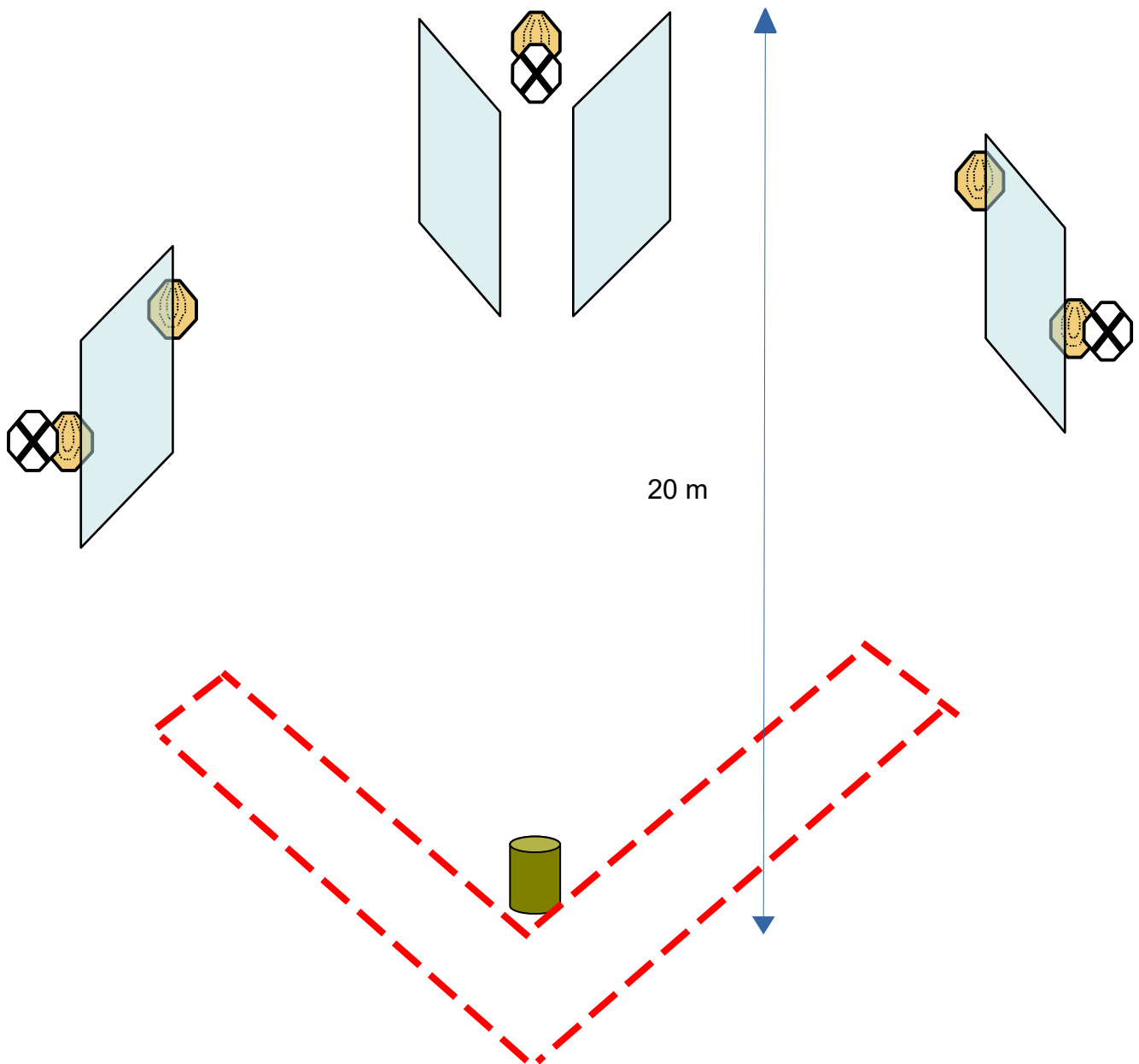

**STAGE: 2** (Short Course).

**TARGETS:** IPSC MINI Targets 5, No-Shoots 3.

**MINIMUM NUMBER OF ROUNDS:** 10.

(Maximum points: 50)

**START POSITION:** Standing erect, anywhere in the designated area, with the rifle in the ready condition, held in both hands, stock touching the competitor at hip level, barrel parallel to the ground, trigger guard downwards, muzzle pointing downrange and with the fingers outside the trigger guard.

**THE RIFLE READY CONDITION:** Loaded (Option 1): magazine filled and fitted, chamber loaded, hammer and/or sear cocked and safety catch applied.

**TIME START:** Audible signal.

**PROCEDURE:** After start signal engage all targets.

# SHOOTING ACADEMY OPEN 2022 (Rifle)

## STAGE 3

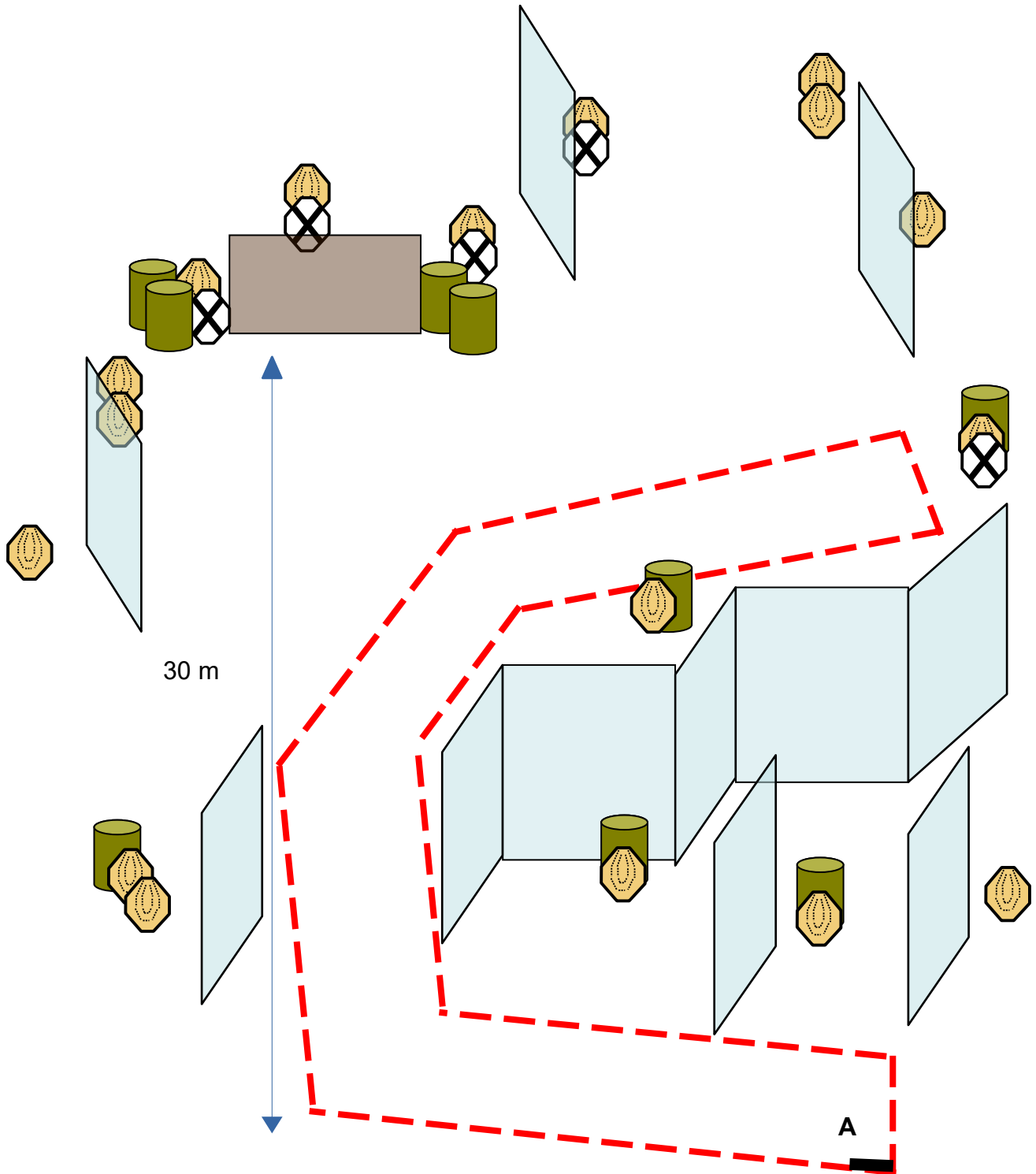

**STAGE: 3** (Long Course).

TARGETS: IPSC MINI Targets 18, No-Shoots 6.

MINIMUM NUMBER OF ROUNDS: 36.

(Maximum points: 180)

START POSITION: Standing erect at **A**, with the rifle in the ready condition, held in both hands, stock touching the competitor at hip level, barrel parallel to the ground, trigger guard downwards, muzzle pointing downrange and with the fingers outside the trigger guard..

THE RIFLE READY CONDITION: Loaded (Option 1): magazine filled and fitted, chamber loaded, hammer and/or sear cocked and safety catch applied.

TIME START: Audible signal.

PROCEDURE: After start signal engage all targets.

# SHOOTING ACADEMY OPEN 2022 (Rifle)

## STAGE 4

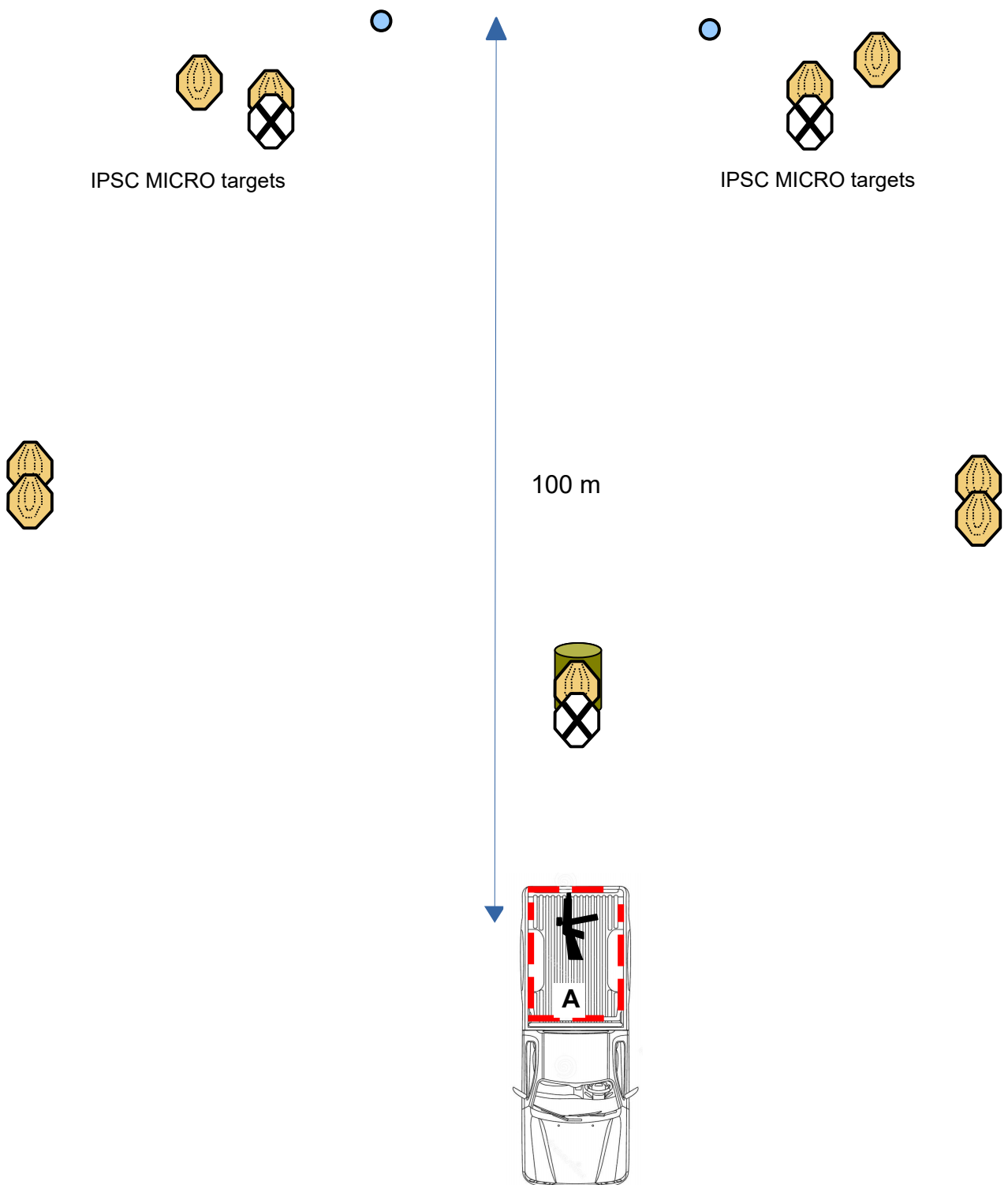

**STAGE: 4** (Medium course).

**TARGETS:** IPSC MICRO Targets 4, IPSC MINI Targets 5, IPSC Plates 2, No-Shoots 3.

**MINIMUM NUMBER OF ROUNDS:** 20.

(Maximum points: 100)

**START POSITION:** Sitting **at A**, in the cargo compartment of a pickup truck, as demonstrated.

**THE RIFLE READY CONDITION:** Loaded (Option 2), magazine filled and fitted, chamber empty, action closed., placed on the pickup cargo compartment floor, muzzle pointed downrange.

**TIME START:** Audible signal.

**PROCEDURE:** After start signal engage all targets.

# SHOOTING ACADEMY OPEN 2022 (Rifle)

## STAGE 5

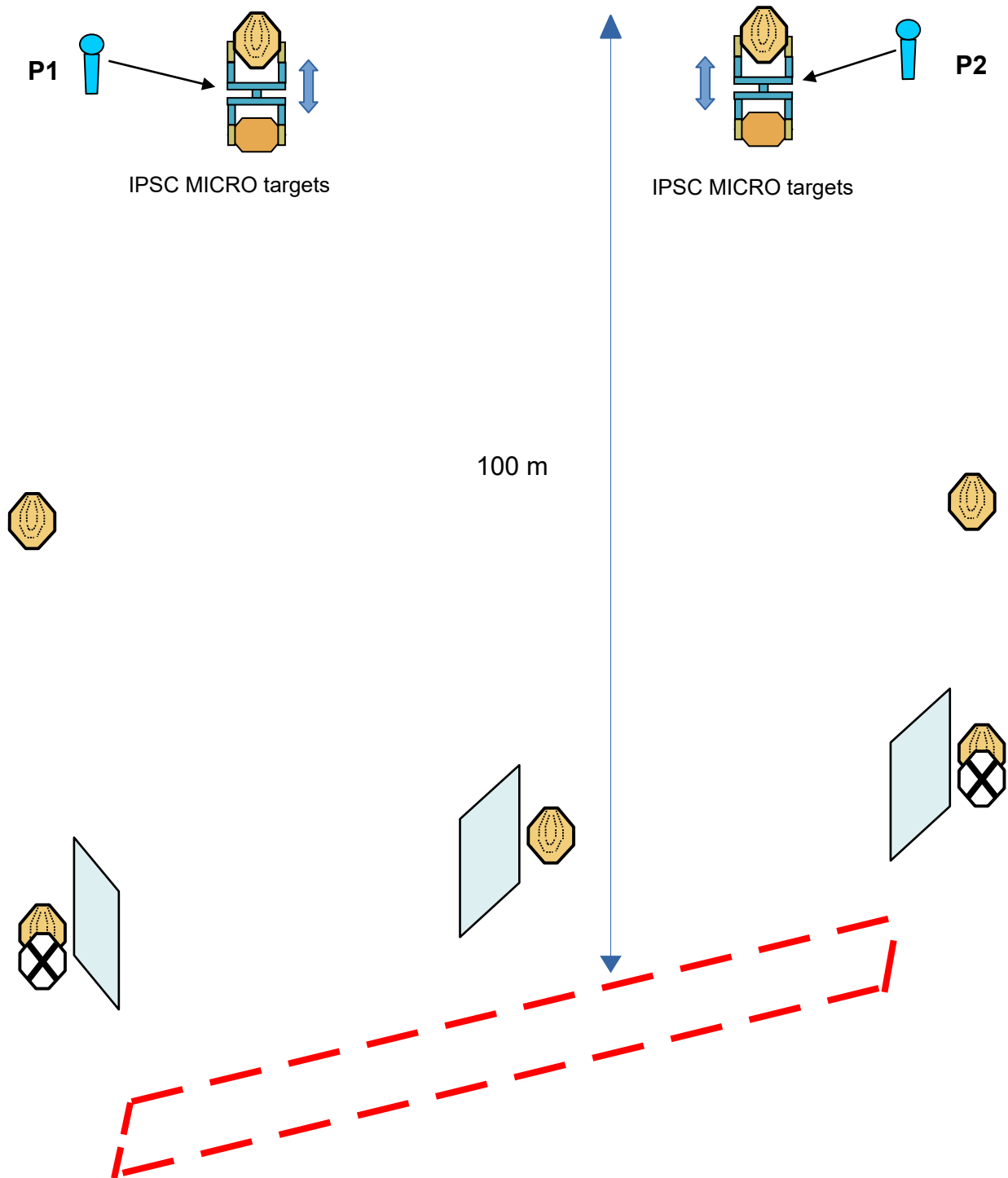

**STAGE: 5** (Medium course).

**TARGETS:** IPSC MICRO Targets 4, IPSC MINI Targets 5, IPSC Poppers 2, No-Shoots 2.

**MINIMUM NUMBER OF ROUNDS:** 20.

(Maximum points: 100)

**START POSITION:** Standing erect, anywhere in the designated area, with the rifle in the ready condition, held in both hands, stock touching the competitor at hip level, barrel parallel to the ground, trigger guard downwards, muzzle pointing downrange and with the fingers outside the trigger guard.

**THE RIFLE READY CONDITION:** Loaded (Option 1): magazine filled and fitted, chamber loaded, hammer and/or sear cocked and safety catch applied.

**TIME START:** Audible signal.

**PROCEDURE:** After start signal engage all targets.

**SPECIAL EQUIPMENT:** Popper P1 and P2 activate changing Micro IPSC targets.

# SHOOTING ACADEMY OPEN 2022 (Rifle)

## STAGE 6

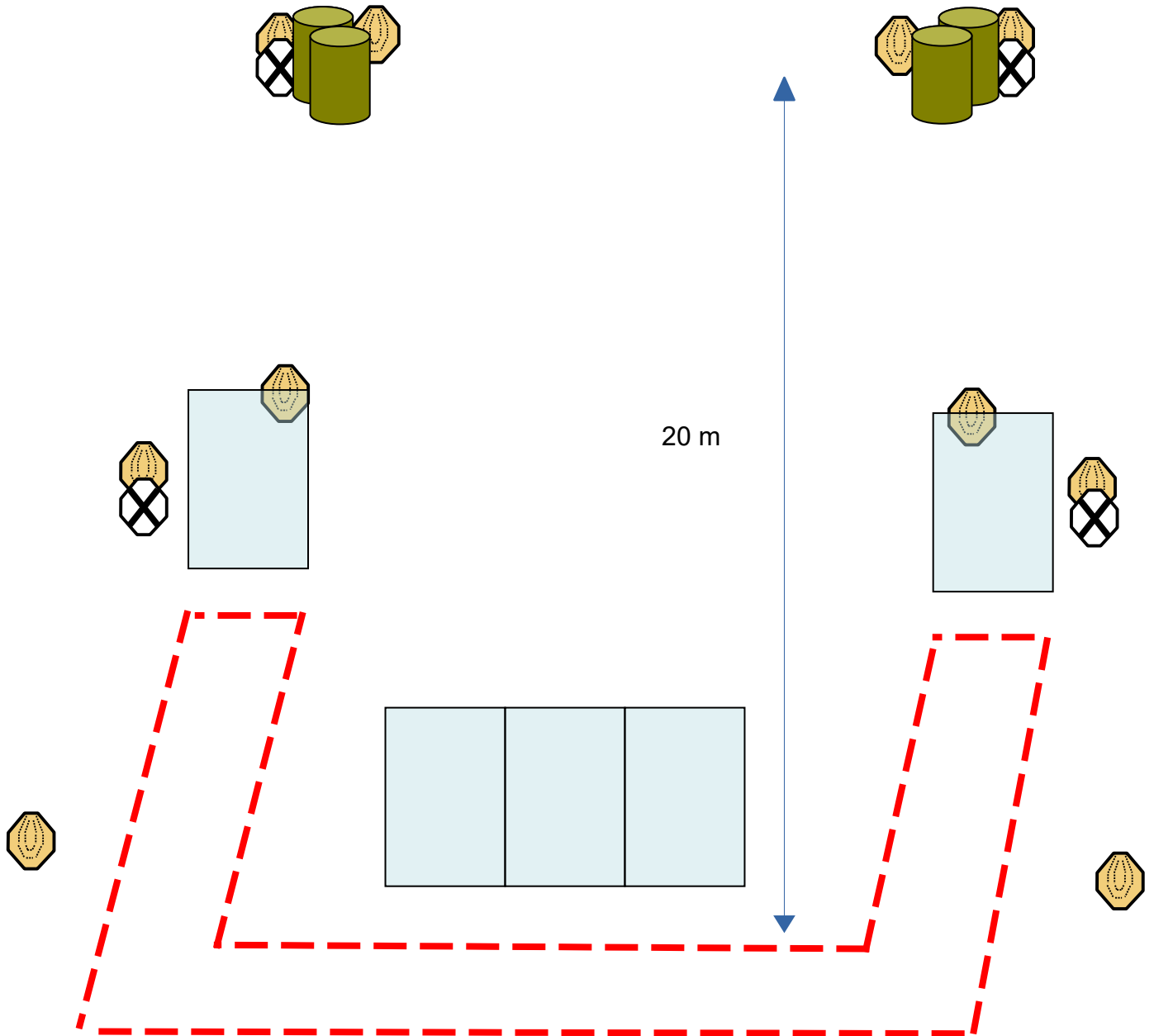

**STAGE: 6** (Medium Course).

TARGETS: IPSC MINI Targets 10, No-Shoots 4.

MINIMUM NUMBER OF ROUNDS: 20.

(Maximum points: 100)

START POSITION: Standing erect, anywhere in the designated area, with the rifle in the ready condition, held in both hands, stock touching the competitor at hip level, barrel parallel to the ground, trigger guard downwards, muzzle pointing downrange and with the fingers outside the trigger guard.

THE RIFLE READY CONDITION: Loaded (Option 1): magazine filled and fitted, chamber loaded, hammer and/or sear cocked and safety catch applied.

TIME START: Audible signal.

PROCEDURE: After start signal engage all targets.

# SHOOTING ACADEMY OPEN 2022 (Rifle)

## STAGE 7

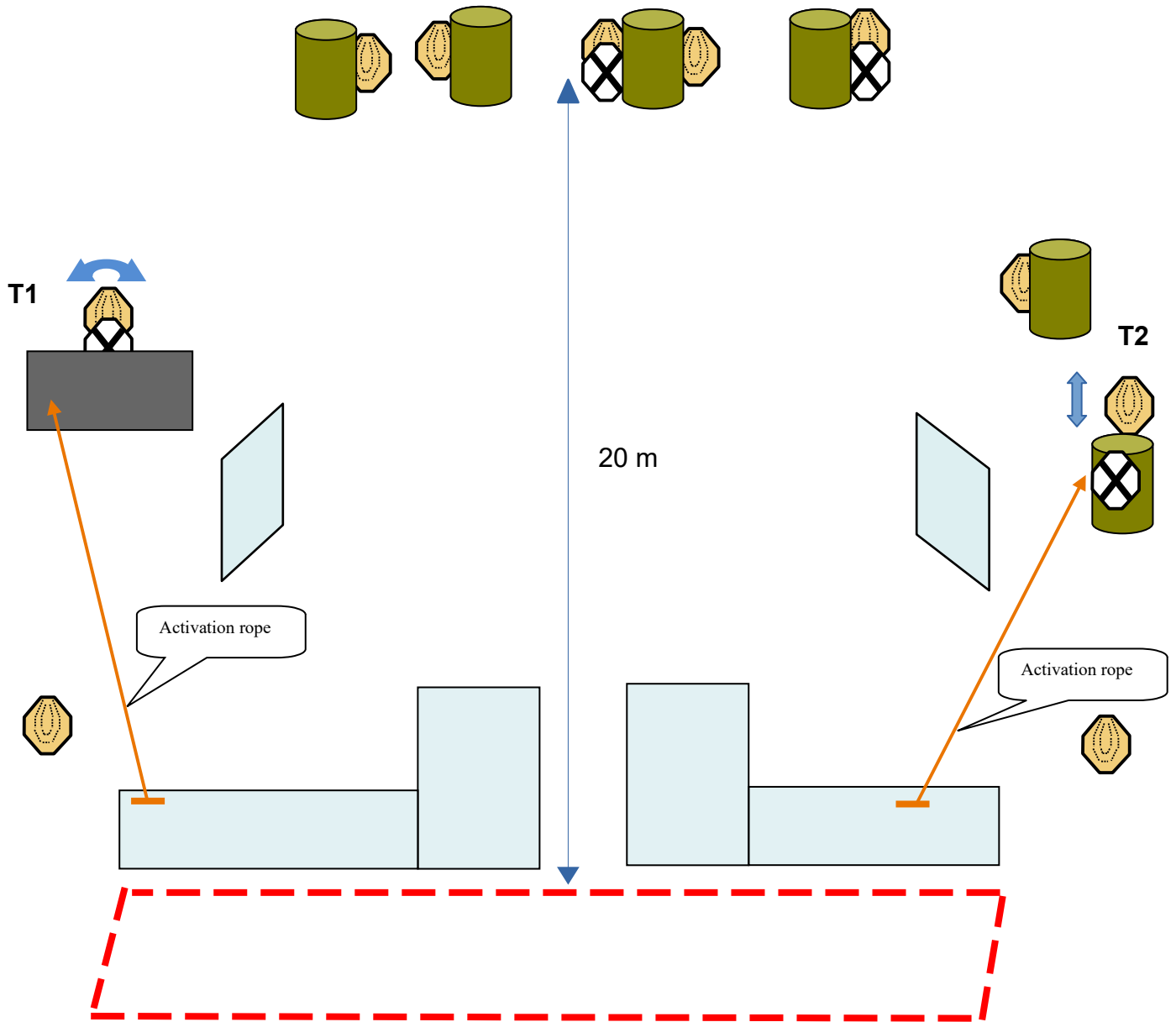

**STAGE: 7** (Medium Course).

**TARGETS:** IPSC MINI Targets 10, No-Shoots 4.

**MINIMUM NUMBER OF ROUNDS:** 20.

(Maximum points: 100)

**START POSITION:** Standing erect, anywhere in the designated area, with the rifle in the ready condition, held in both hands, stock touching the competitor at hip level, barrel parallel to the ground, trigger guard downwards, muzzle pointing downrange and with the fingers outside the trigger guard.

**THE RIFLE READY CONDITION:** Loaded (Option 1): magazine filled and fitted, chamber loaded, hammer and/or sear cocked and safety catch applied.

**TIME START:** Audible signal.

**PROCEDURE:** After start signal engage all targets.

**SPECIAL EQUIPMENT:** Swinger T1 and Up-down moving target T2 activates by rope. Both moving targets remain visible at rest.

# SHOOTING ACADEMY OPEN 2022 (Rifle)

## STAGE 8

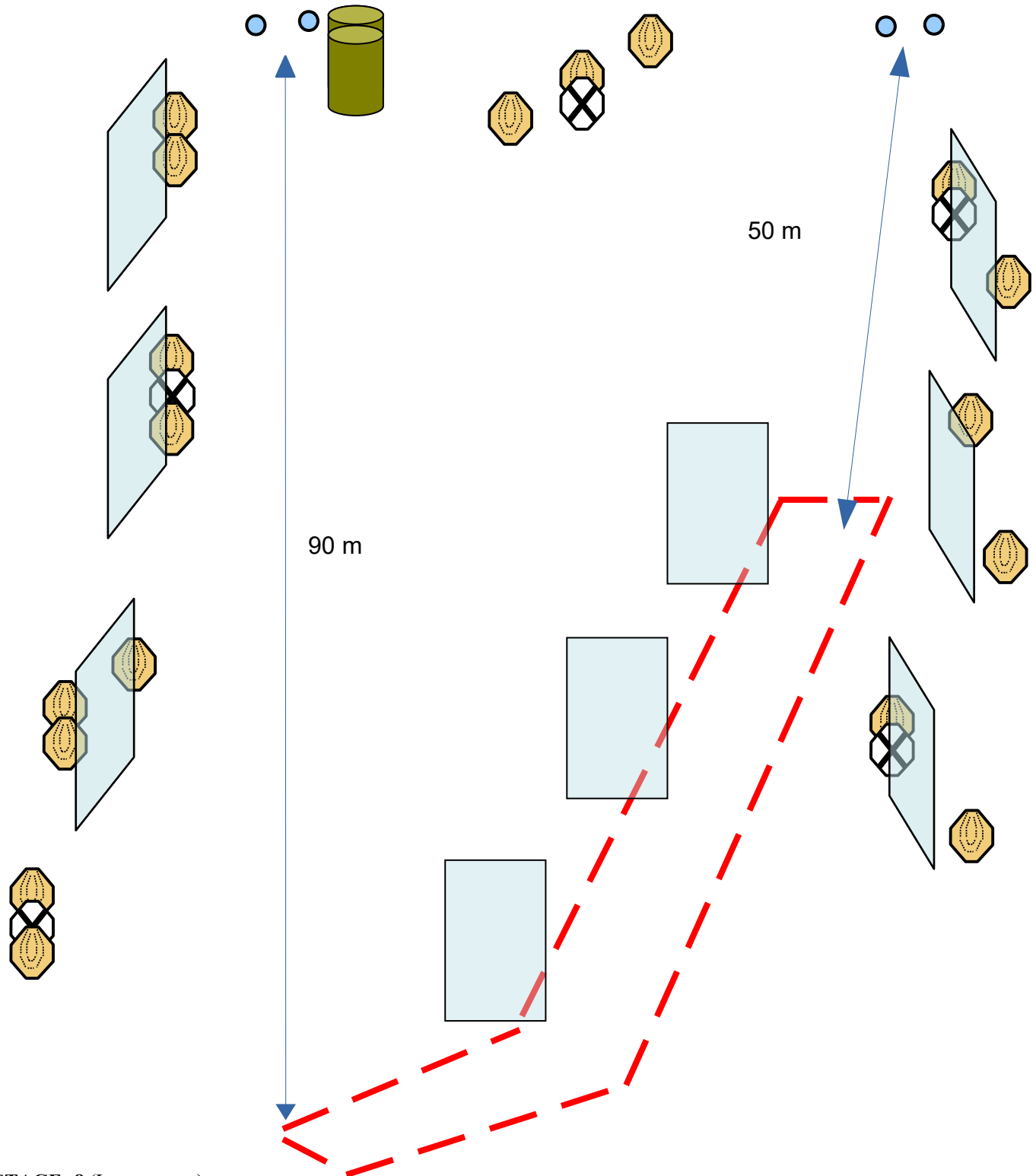

### STAGE: 8 (Long course).

TARGETS: IPSC MINI Targets 18, IPSC Platwies 4, No-Shoots 5.

MINIMUM NUMBER OF ROUNDS: 40.

(Maximum points: 200)

START POSITION: Standing erect, anywhere in the designated area, with the rifle in the ready condition, held in both hands, stock touching the competitor at hip level, barrel parallel to the ground, trigger guard downwards, muzzle pointing downrange and with the fingers outside the trigger guard.

THE RIFLE READY CONDITION: Loaded (Option 1): magazine filled and fitted, chamber loaded, hammer and/or sear cocked and safety catch applied.

TIME START: Audible signal.

PROCEDURE: After start signal engage all targets.



# SHOOTING ACADEMY OPEN 2022 (Rifle)

## STAGE 9

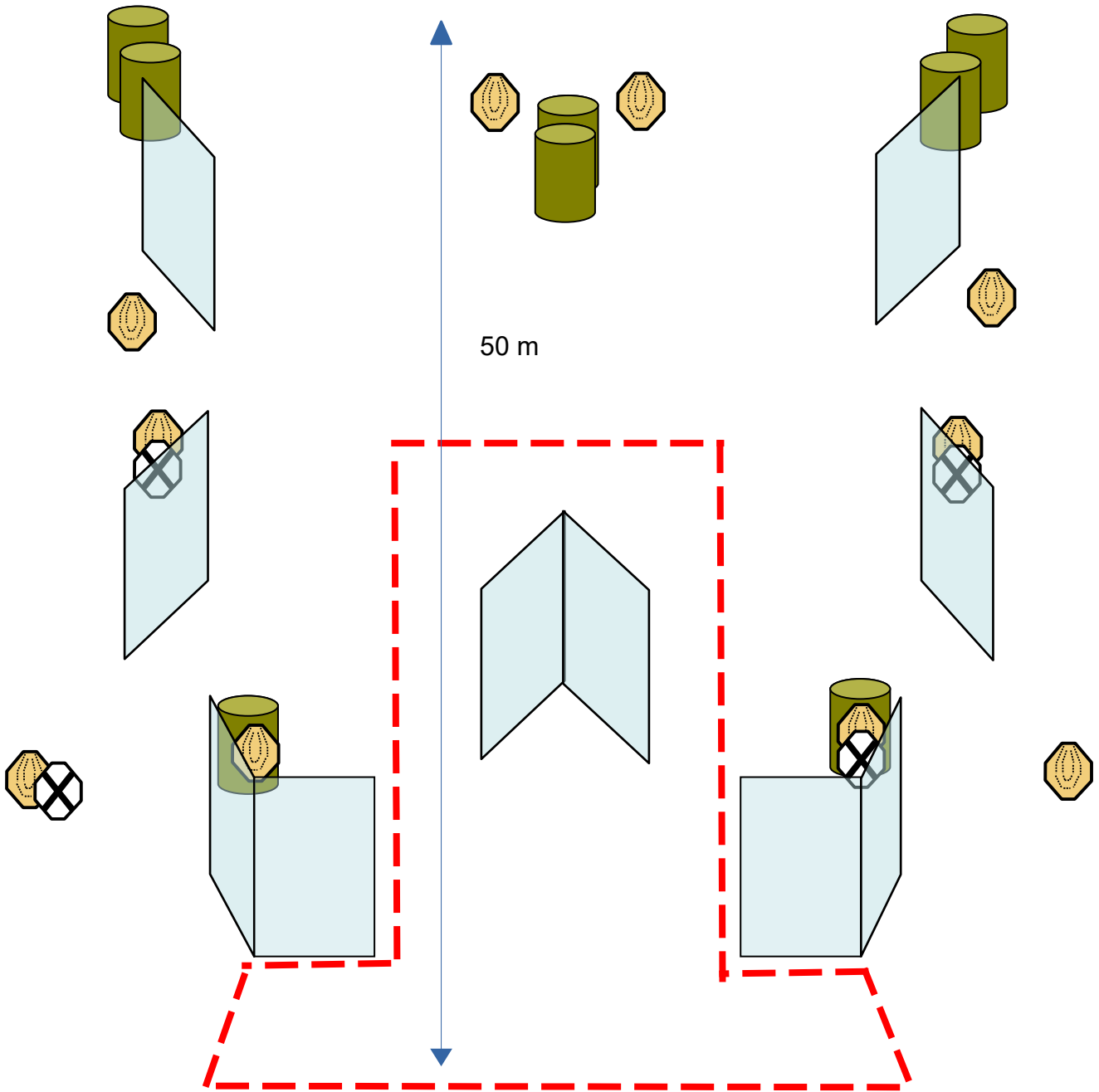

**STAGE: 9** (Medium Course).

TARGETS: IPSC MINI Targets 10, No-Shoots 4.

MINIMUM NUMBER OF ROUNDS: 20.

(Maximum points: 100)

START POSITION: Standing erect, anywhere in the designated area, with the rifle in the ready condition, held in both hands, stock touching the competitor at hip level, barrel parallel to the ground, trigger guard downwards, muzzle pointing downrange and with the fingers outside the trigger guard.

THE RIFLE READY CONDITION: Loaded (Option 1): magazine filled and fitted, chamber loaded, hammer and/or sear cocked and safety catch applied.

TIME START: Audible signal.

PROCEDURE: After start signal engage all targets.

# SHOOTING ACADEMY OPEN 2022 (Rifle)

## STAGE 10

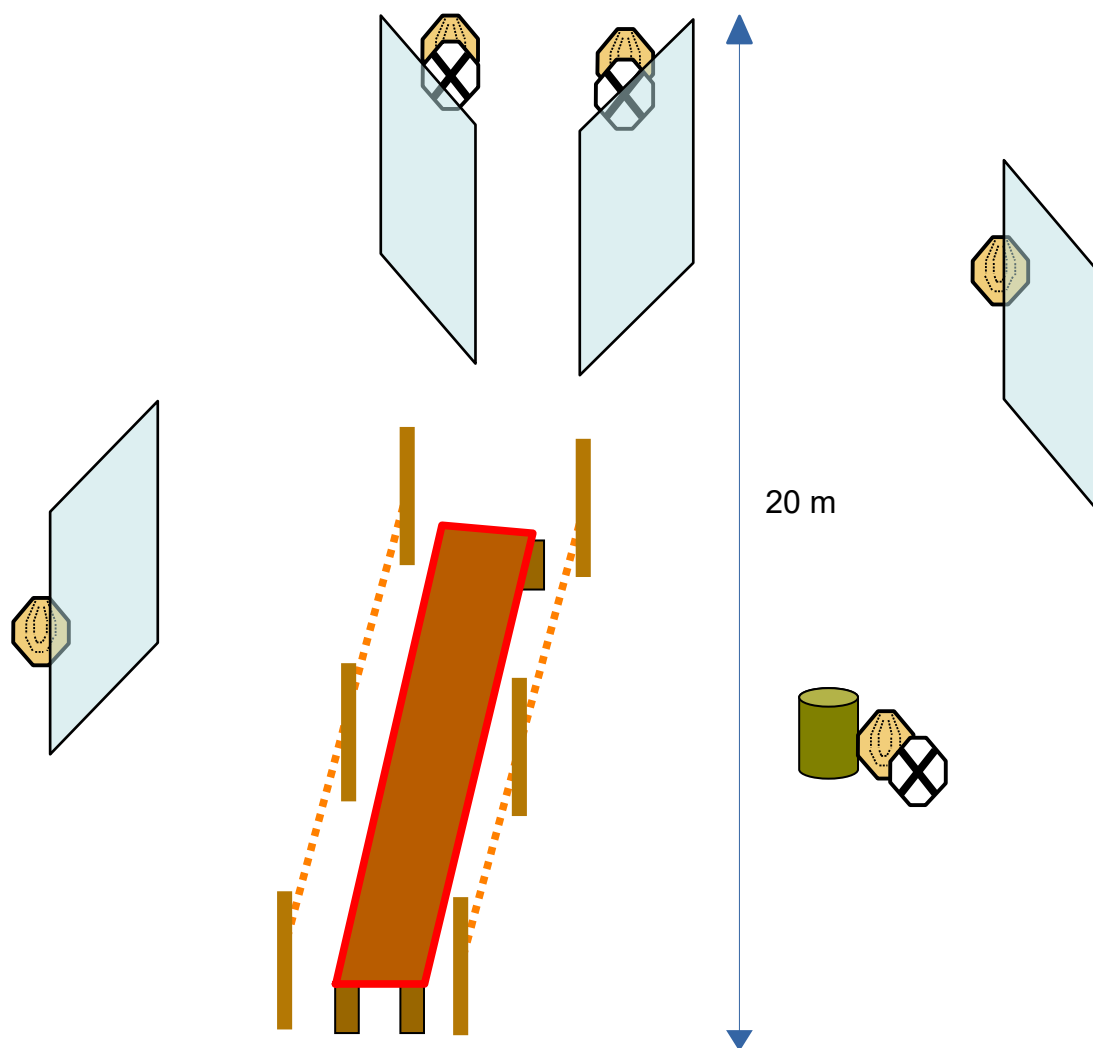

**STAGE: 10** (Short Course).

TARGETS: IPSC MINI Targets 5, No-Shoots 3.

MINIMUM NUMBER OF ROUNDS: 10.

(Maximum points: 50)

START POSITION: Standing erect, anywhere on the platform, with the rifle in the ready condition, held in both hands, stock touching the competitor at hip level, barrel parallel to the ground, trigger guard downwards, muzzle pointing downrange and with the fingers outside the trigger guard.

THE RIFLE READY CONDITION: Loaded (Option 1): magazine filled and fitted, chamber loaded, hammer and/or sear cocked and safety catch applied.

TIME START: Audible signal.

PROCEDURE: After start signal engage all targets, moving and shooting from the elevated platform only.

# SHOOTING ACADEMY OPEN 2022 (Rifle)

## STAGE 11

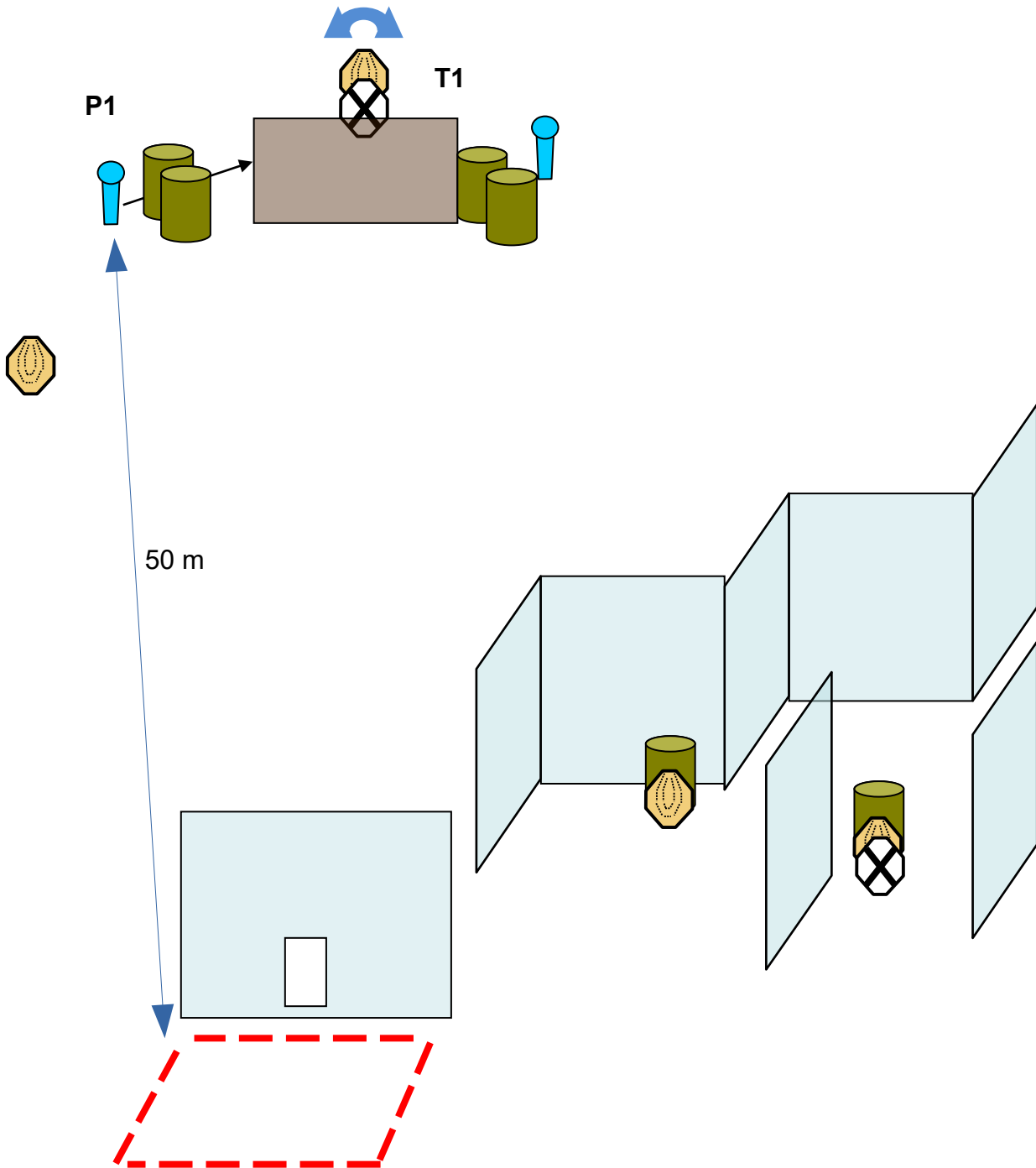

**STAGE: 11** (Short course).

**TARGETS:** IPSC MINI Targets 4, IPSC MINI Poppers 2, No-Shoots 2.

**MINIMUM NUMBER OF ROUNDS:** 10.

(Maximum points: 50)

**START POSITION:** Standing erect, anywhere in the designated area, with the rifle in the ready condition, held in both hands, stock touching the competitor at hip level, barrel parallel to the ground, trigger guard downwards, muzzle pointing downrange and with the fingers outside the trigger guard.

**THE RIFLE READY CONDITION:** Loaded (Option 1): magazine filled and fitted, chamber loaded, hammer and/or sear cocked and safety catch applied.

**TIME START:** Audible signal.

**PROCEDURE:** After start signal engage all targets.

**SPECIAL EQUIPMENT:** Popper P1 activates Swinger T1 which remains visible at rest.

# SHOOTING ACADEMY OPEN 2022 (Rifle)

## STAGE 12

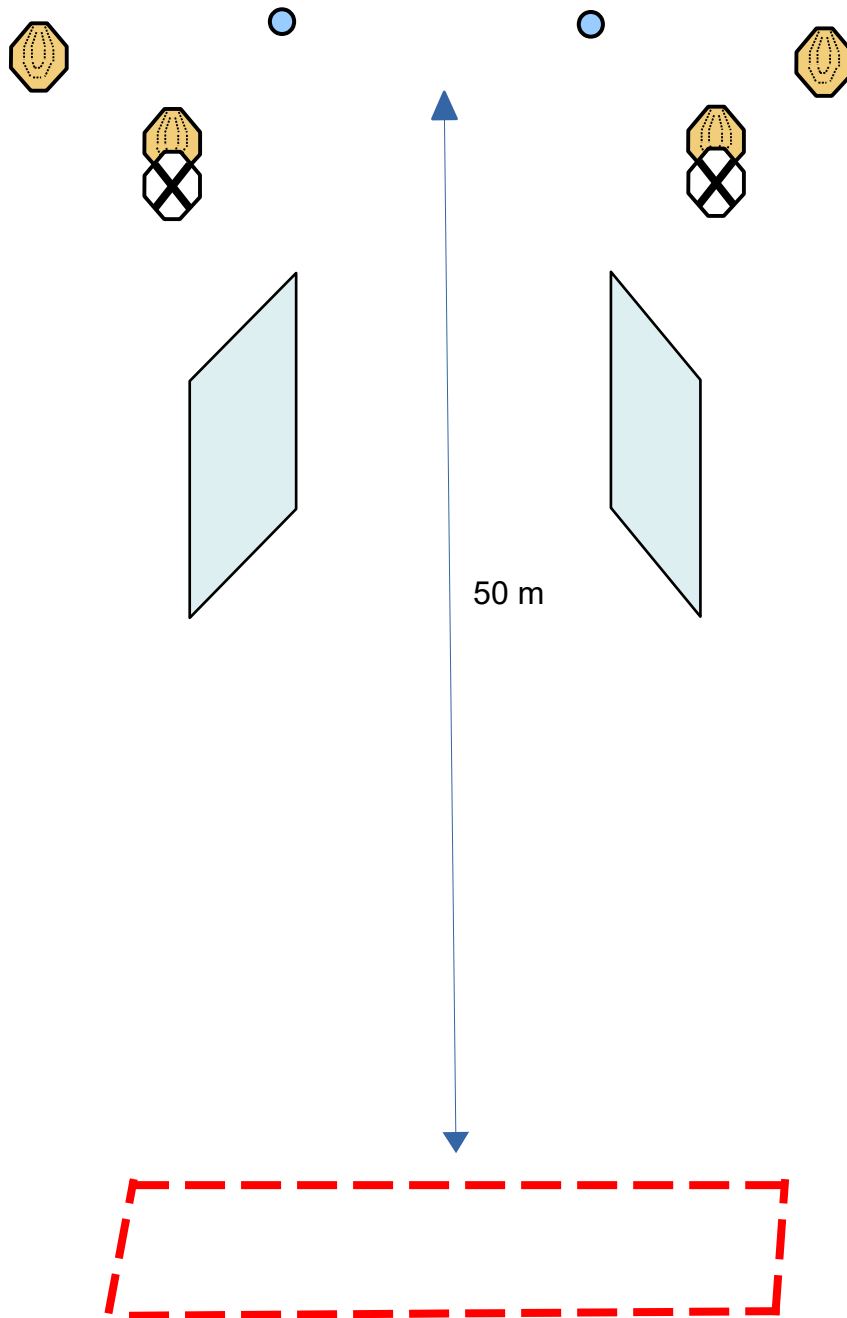

**STAGE: 12** (Short course).

**TARGETS:** IPSC MICRO Targets 4, IPSC Plates 2, No-Shoots 2.

**MINIMUM NUMBER OF ROUNDS:** 10.

(Maximum points: 50)

**START POSITION:** Standing erect, anywhere in the designated area, with the rifle in the ready condition, held in both hands, stock touching the competitor at hip level, barrel parallel to the ground, trigger guard downwards, muzzle pointing downrange and with the fingers outside the trigger guard.

**THE RIFLE READY CONDITION:** Loaded (Option 1): magazine filled and fitted, chamber loaded, hammer and/or sear cocked and safety catch applied.

**TIME START:** Audible signal.

**PROCEDURE:** After start signal engage all targets..

# SHOOTING ACADEMY OPEN 2022 (Rifle)

## STAGE 13

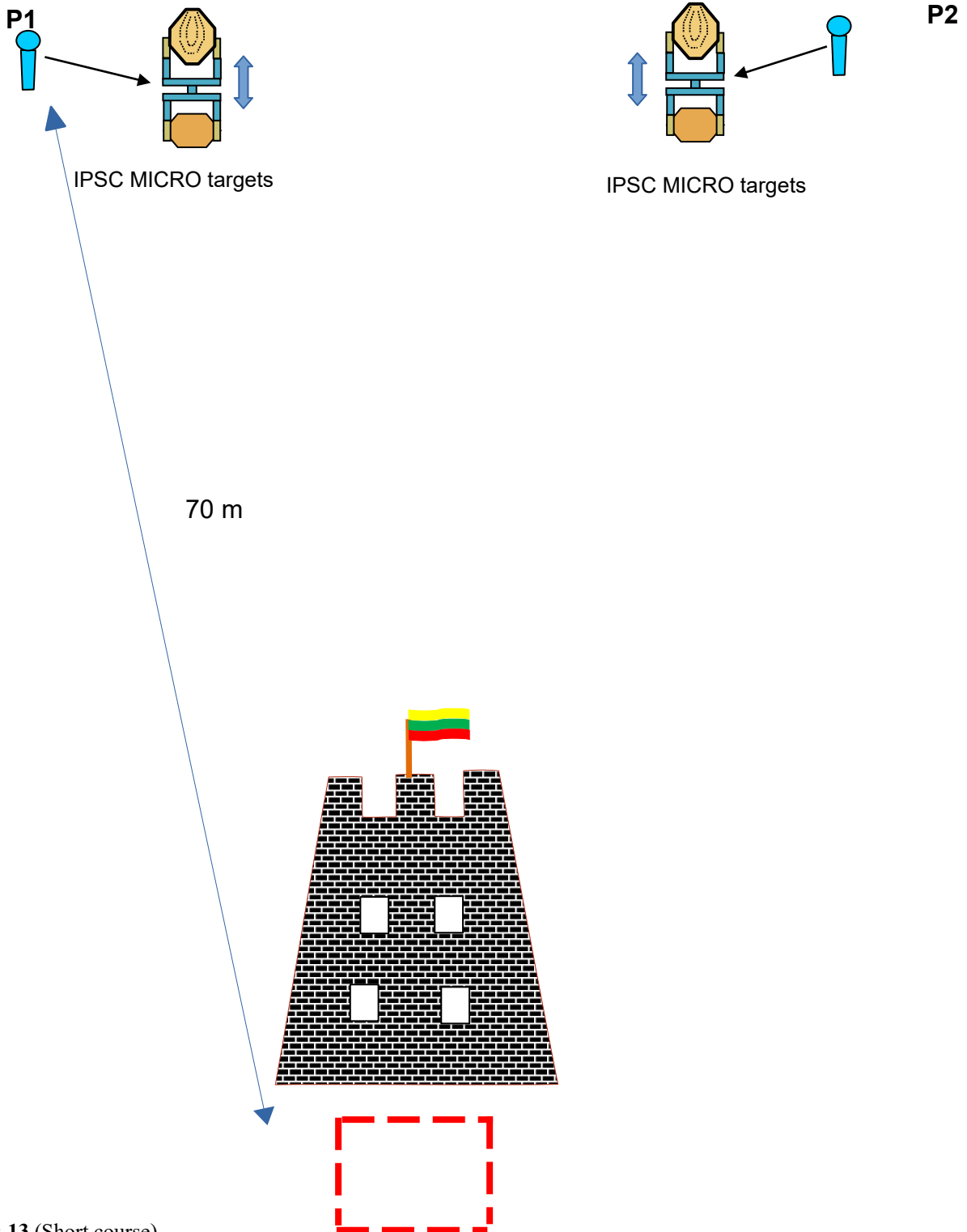

**STAGE: 13** (Short course).

**TARGETS:** IPSC MICRO Targets 4, IPSC Poppers 2.

**MINIMUM NUMBER OF ROUNDS:** 10.

(Maximum points: 50)

**START POSITION:** Standing erect, anywhere in the designated area, with the rifle in the ready condition, held in both hands, stock touching the competitor at hip level, barrel parallel to the ground, trigger guard downwards, muzzle pointing downrange and with the fingers outside the trigger guard.

**THE RIFLE READY CONDITION:** Loaded (Option 1): magazine filled and fitted, chamber loaded, hammer and/or sear cocked and safety catch applied.

**TIME START:** Audible signal.

**PROCEDURE:** After start signal engage all targets.

**SPECIAL EQUIPMENT:** Popper P1 and P2 activate changing Micro IPSC targets.

# SHOOTING ACADEMY OPEN 2022 (Rifle)

## STAGE 14

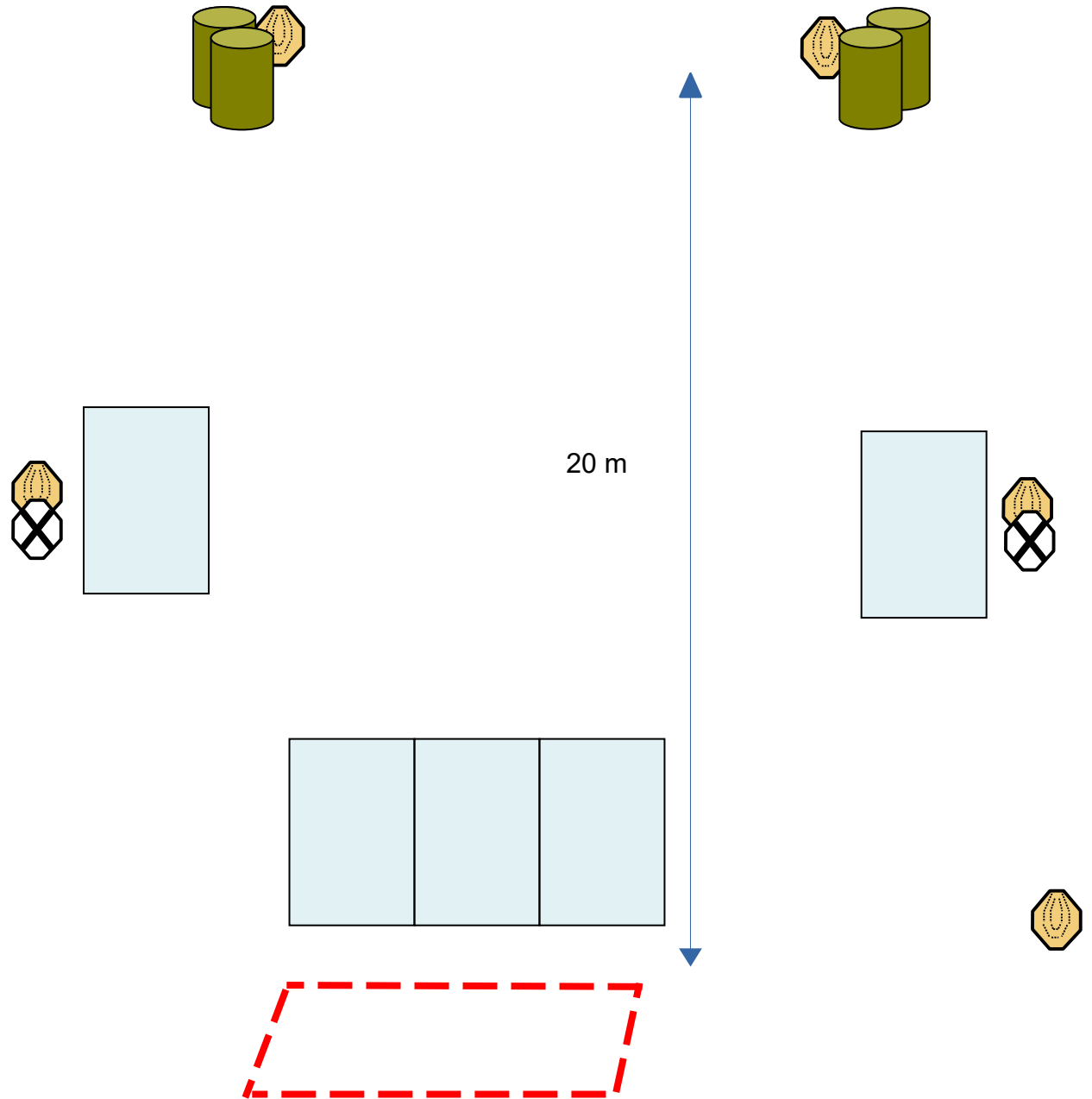

**STAGE: 14** (Short Course).

TARGETS: IPSC MINI Targets 5, No-Shoots 2.

MINIMUM NUMBER OF ROUNDS: 10.

(Maximum points: 50)

START POSITION: Standing erect, anywhere in the designated area, with the rifle in the ready condition, held in both hands, stock touching the competitor at hip level, barrel parallel to the ground, trigger guard downwards, muzzle pointing downrange and with the fingers outside the trigger guard.

THE RIFLE READY CONDITION: Loaded (Option 1): magazine filled and fitted, chamber loaded, hammer and/or sear cocked and safety catch applied.

TIME START: Audible signal.

PROCEDURE: After start signal engage all targets.

## SHOOTING ACADEMY OPEN 2022 (Rifle)

### STAGE 15

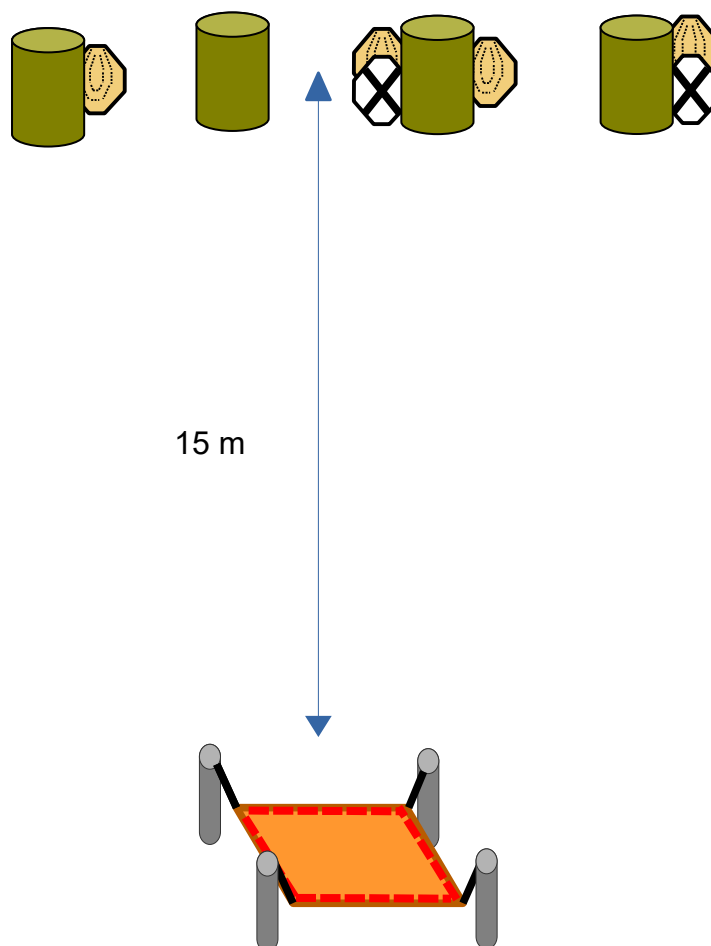

**STAGE: 15** (Short Course).

TARGETS: IPSC MINI Targets 5, No-Shoots 2.

MINIMUM NUMBER OF ROUNDS: 10.

(Maximum points: 50)

START POSITION: Standing erect on the platform within the designated area, with the rifle in the ready condition, held in both hands, stock touching the competitor at hip level, barrel parallel to the ground, trigger guard downwards, muzzle pointing downrange and with the fingers outside the trigger guard..

THE RIFLE READY CONDITION: Loaded (Option 1): magazine filled and fitted, chamber loaded, hammer and/or sear cocked and safety catch applied.

TIME START: Audible signal.

PROCEDURE: After start signal engage all targets with mandatory magazine change – **mandatory reload** must be completed after the competitor shoots at his first target, and before he shoots at his final target.

# SHOOTING ACADEMY OPEN 2022 (Rifle)

## STAGE 16

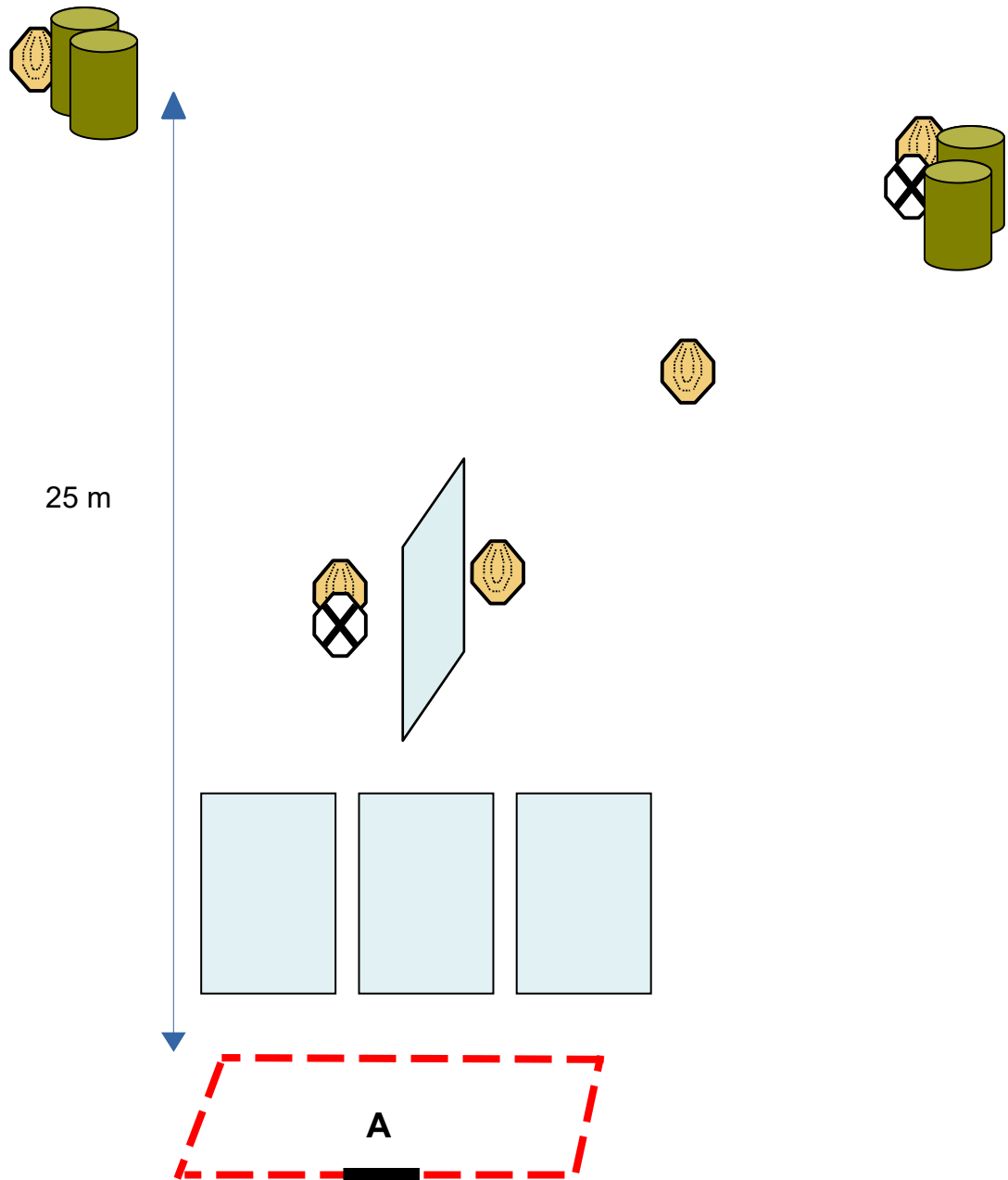

**STAGE: 16** (Short Course).

TARGETS: IPSC MINI Targets 5, No-Shoots 2.

MINIMUM NUMBER OF ROUNDS: 10.

(Maximum points: 50)

START POSITION: Standing erect **at A**, with the rifle in the ready condition, held in both hands, stock touching the competitor at hip level, barrel parallel to the ground, trigger guard downwards, muzzle pointing downrange and with the fingers outside the trigger guard.

THE RIFLE READY CONDITION: Loaded (Option 2), magazine filled and fitted, chamber empty, action closed.

TIME START: Audible signal.

PROCEDURE: After start signal engage all targets.



# SHOOTING ACADEMY OPEN 2022 (Rifle)

## Summary:

**Match ID:** D67133919  
**Match Name:** Shooting Academy Rifle 2022  
**Level:** III  
**Region:** Lithuania  
**City:** Vilnius  
**Club:** Suvio Akademija  
**Match Date:** 2022-04-30  
**Discipline:** Rifle  
**Number of Days:** 2  
**Minimum Rounds:** 276  
**Number of Stages:** 16

Long course – 2  
Medium course – 6  
Short course – 8

IPSC MINI Targets – 114  
IPSC MICRO Targets – 16  
IPSC Poppers – 6  
IPSC Plates – 10  
No-Shoots – ...

Minimum Rounds – 276  
Maximum points - 1380

